

# TVS Diodes

Transient Voltage Suppression Diodes

8.0SMDJ Series



## Description

Transient Voltage Suppressor (TVS) is a circuit protection component that either attenuates (reduces) or filters a transient voltage spike (overvoltage), TVS diodes provide critical protection by going into avalanche breakdown within no more than a few nanoseconds after a strike, clamping the transient voltage, and routing its current to the ground.

## Applications

- Communication Equipment
- Security & Protection
- Industrial Control Equipment
- Power Supply
- Automotive Electronics
- New Energy
- Lightning Protection

## Functional Diagram

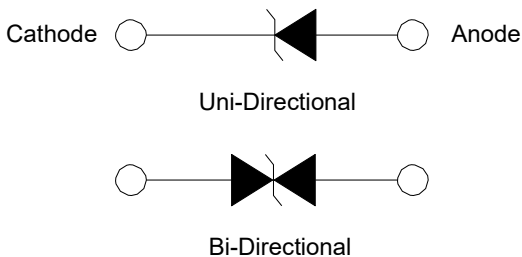

## Features

- 8000 W peak pulse power capability with a 10/1000  $\mu$ s Waveform, repetition rate (duty cycles): 0.01%
- Low incremental surge resistance
- Excellent clamping capability
- Low profile package with built-in strain relief
- Typical  $I_R$  less than 5  $\mu$ A when  $V_{BR}$  min > 22 V
- For surface mounted applications to optimize board space
- Typical failure mode is short from over-specified voltage or current
- IEC 61000-4-2 ESD 30 kV (Air), 30 kV (Contact)
- EFT protection of data lines in accordance with IEC 61000-4-4
- Very fast response time
- Glass passivated chip junction
- High temperature to reflow soldering guaranteed: 260 °C / 40 sec
- $V_{BR} @ T_J = V_{BR@25\text{ }^\circ\text{C}} \times (1 + \alpha T \times (T_J - 25))$   
( $\alpha T$ : Temperature Coefficient, typical value is 0.1%)
- Plastic package is flammability rated V-0 per Underwriters Laboratories
- Meet MSL level1, per J-STD-020,
- Matte tin lead-free plated
- Halogen free and RoHS compliant
- Pb-free E3 means 2nd level interconnect is Pb-free and the terminal finish material is tin(Sn) (IPC/JEDEC J-STD-609A.01)

Package Outline Dimensions (DO-214AB)

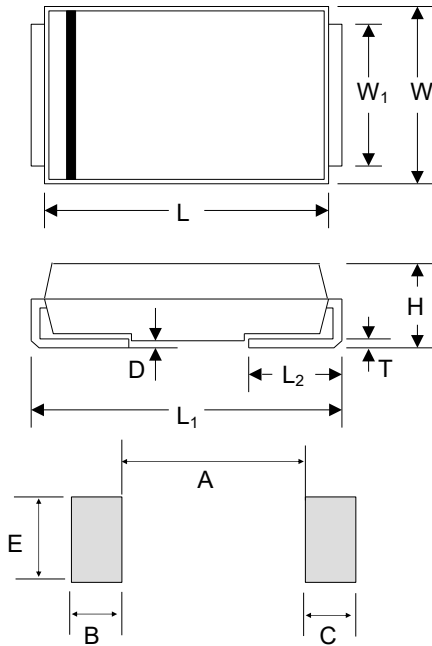

Mounting Pad Layout

Symbol	Millimeters		Inches	
	Min.	Max.	Min.	Max.
L	6.60	7.11	0.260	0.280
W	5.59	6.22	0.220	0.245
W <sub>1</sub>	2.90	3.20	0.114	0.126
H	2.06	2.62	0.079	0.103
T	0.152	0.305	0.006	0.012
L <sub>1</sub>	7.75	8.13	0.305	0.320
L <sub>2</sub>	0.76	1.52	0.030	0.060
D	-	0.203	-	0.008
A	-	4.20	-	0.165
B	2.40	-	0.094	-
C	2.40	-	0.094	-
E	3.30	-	0.129	-

Maximum Ratings and Characteristics

(Ratings at 25 °C ambient temperature unless otherwise specified.)

Parameter	Symbol	Value	Unit
Peak Pulse Power Dissipation at T <sub>L</sub> =25 °C by 10/1000 μs waveform <sup>(1)(2)</sup> (Fig.2)	P <sub>PPM</sub>	8000	W
Peak Power Dissipation on Infinite Heat Sink at T <sub>L</sub> =50 °C	P <sub>D</sub>	6.5	W
Peak Forward Surge Current, 8.3 ms single half sine wave superimposed on rated load (JEDEC Method) <sup>(3)</sup>	I <sub>FSM</sub>	300	A
Maximum Instantaneous Forward Voltage at 100 A for Unidirectional Only	V <sub>F</sub>	5.0	V
Operating Temperature Range	T <sub>J</sub>	-65 to 150	°C
Storage Temperature Range	T <sub>STG</sub>	-65 to 175	°C
Typical Thermal Resistance Junction to Lead	R <sub>θJL</sub>	15	°C / W
Typical Thermal Resistance Junction to Ambient	R <sub>θJA</sub>	75	°C / W

Notes

1. Non-repetitive current pulse, per Fig. 4 and derated above T<sub>J</sub>(initial)=25 °C per Fig. 3.
2. Mounted on 8.0 mm<sup>2</sup> land areas.
3. Measured of 8.3 ms single half sine-wave or equivalent square wave, duty cycle=4 pulses per minute maximum.

# TVS Diodes

Transient Voltage Suppression Diodes

8.0SMDJ Series

## Part Numbering System

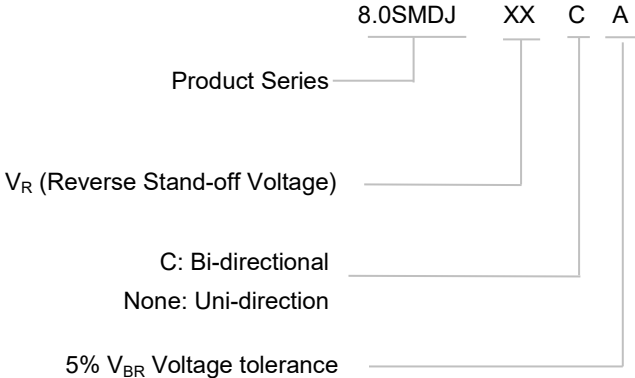

## Marking

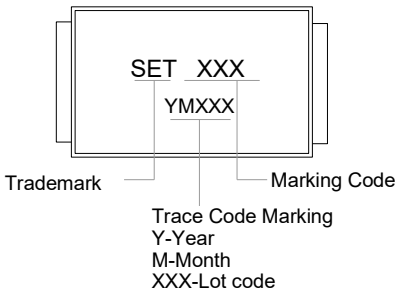
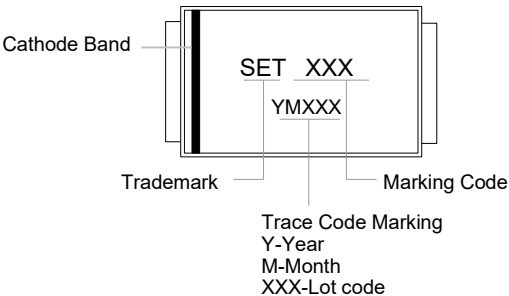

## Glossary

Item	Description
$V_C$	<b>Clamping Voltage</b> Voltage across TVS in a region of low differential resistance that serves to limit the voltage across the device terminals.
$V_R$	<b>Reverse Stand-off Voltage</b> Maximum voltage that can be applied to the TVS without operation. NOTE : It is also shown as $V_{WM}$ (maximum working voltage (maximum d.c. voltage)) and known as rated stand-off voltage ( $V_{SO}$ ).
$I_R$	<b>Reverse Leakage Current</b> Current measured at $V_R$ .
$V_{BR}$	<b>Breakdown Voltage</b> Voltage across TVS at a specified current $I_T$ in the breakdown region.
$I_{PPM}$	<b>Rated Random Recurring Peak Impulse Current</b> Maximum-rated value of random recurring peak impulse current that may be applied to a device.
$P_{M(AV)}$	<b>Rated Average Power Dissipation</b> Maximum-rated value of power dissipation resulting from all sources, including transients and standby current, averaged over a short period of time.
$P_{PPM}$	<b>Rated Random Recurring Peak Impulse Power Dissipation</b> Maximum-rated value of the product of rated random recurring peak impulse current ( $I_{PPM}$ ) multiplies by specified maximum clamping voltage ( $V_C$ ).
$C_J$	<b>Capacitance</b> Capacitance across the TVS measured at a specified frequency and voltage.
$V_{FS}$	<b>Peak Forward Surge Voltage</b> Peak voltage across an TVS for a specified forward surge current ( $I_{FS}$ ) and time duration. NOTE : Also shown as $V_F$ .
$I_{FS}$	<b>Forward Surge Current</b> Pulsed current through TVS in the forward conducting region. NOTE : Also shown as $I_F$ .
$\alpha_{V(BR)}$	<b>Temperature Coefficient of Breakdown Voltage</b> The change of breakdown voltage divided by the change of temperature.
$I_{PP}$	<b>Peak pulse Current</b> Peak pulse current value applied across the TVS to determine the clamping voltage $V_C$ for a specified wave shape.
$I_T$	<b>Pulsed D.C. Test Current</b> Test current for measurement of the breakdown voltage $V_{BR}$ . This is defined by the manufacturer and usually given in milliamperes with a pulse duration of less than 40 ms. NOTE : Also shown as $I_{BR}$ .

—(GB-T 18802.321 / IEC 61643-321 / JESD210A)

# TVS Diodes

Transient Voltage Suppression Diodes

8.0SMDJ Series

## Electrical Characteristics (T<sub>A</sub>=25 °C unless otherwise noted )Table 1

Part Number		Device Marking Code		Breakdown Voltage V <sub>BR@I<sub>T</sub></sub>		Test Current I <sub>T</sub>	Reverse Stand-off Voltage V <sub>R</sub>	Max. Reverse Leakage I <sub>R@V<sub>R</sub></sub>	Max. Peak Pulse Current I <sub>PPM</sub> (10/1000 μS)	Max. Clamping Voltage V <sub>C@I<sub>PPM</sub></sub> (10/1000 μS)	Max. Clamping Voltage V <sub>C@I<sub>PPM</sub></sub> (8/20 μS)	Max. Peak Pulse Current I <sub>PPM</sub> (8/20 μS)
				Min	Max							
Uni	Bi	Uni	Bi	(V)		(mA)	(V)	(μA)	(A)	(V)	(A)	(V)
8.0SMDJ12A	8.0SMDJ12CA	8PEP	8BEP	13.30	14.70	10	12.00	800.00	402.10	19.90	25.70	2613.70
8.0SMDJ13A	8.0SMDJ13CA	8PEQ	8BEQ	14.40	15.90	10	13.00	500.00	372.10	21.50	27.80	2418.70
8.0SMDJ14A	8.0SMDJ14CA	8PER	8BER	15.60	17.20	10	14.00	200.00	344.90	23.20	30.00	2241.90
8.0SMDJ15A	8.0SMDJ15CA	8PES	8BES	16.70	18.50	1	15.00	100.00	327.90	24.40	31.50	2131.40
8.0SMDJ16A	8.0SMDJ16CA	8PET	8BET	17.80	19.70	1	16.00	50.00	307.70	26.00	33.60	2000.10
8.0SMDJ17A	8.0SMDJ17CA	8PEU	8BEU	18.90	20.90	1	17.00	20.00	290.00	27.60	35.70	1885.00
8.0SMDJ18A	8.0SMDJ18CA	8PEV	8BEV	20.00	22.10	1	18.00	10.00	274.00	29.20	37.70	1781.00
8.0SMDJ20A	8.0SMDJ20CA	8PEW	8BEW	22.20	24.50	1	20.00	5.00	247.00	32.40	41.90	1605.50
8.0SMDJ22A	8.0SMDJ22CA	8PEX	8BEX	24.40	26.90	1	22.00	5.00	225.40	35.50	45.90	1464.80
8.0SMDJ24A	8.0SMDJ24CA	8PEZ	8BEZ	26.70	29.50	1	24.00	5.00	205.70	38.90	50.30	1336.80
8.0SMDJ26A	8.0SMDJ26CA	8PFE	8BFE	28.90	31.90	1	26.00	5.00	190.10	42.10	54.40	1235.70
8.0SMDJ28A	8.0SMDJ28CA	8PFG	8BFG	31.10	34.40	1	28.00	5.00	176.20	45.40	58.70	1145.40
8.0SMDJ30A	8.0SMDJ30CA	8PFK	8BFK	33.30	36.80	1	30.00	5.00	165.30	48.40	62.50	1074.50
8.0SMDJ33A	8.0SMDJ33CA	8PFM	8BFM	36.70	40.60	1	33.00	5.00	150.10	53.30	68.90	975.70
8.0SMDJ36A	8.0SMDJ36CA	8PFP	8BFP	40.00	44.20	1	36.00	5.00	137.80	58.10	75.10	895.70
8.0SMDJ40A	8.0SMDJ40CA	8PFR	8BFR	44.40	49.10	1	40.00	5.00	124.10	64.50	83.30	806.70
8.0SMDJ43A	8.0SMDJ43CA	8PFT	8BFT	47.80	52.80	1	43.00	5.00	115.30	69.40	89.70	749.50
8.0SMDJ45A	8.0SMDJ45CA	8PFV	8BFV	50.00	55.30	1	45.00	5.00	110.10	72.70	93.90	715.70
8.0SMDJ48A	8.0SMDJ48CA	8PFX	8BFX	53.30	58.90	1	48.00	5.00	103.40	77.40	100.00	671.80
8.0SMDJ51A	8.0SMDJ51CA	8PFZ	8BFZ	56.70	62.70	1	51.00	5.00	97.10	82.40	106.50	631.20
8.0SMDJ54A	8.0SMDJ54CA	8PGE	8BGE	60.00	66.30	1	54.00	5.00	92.00	87.10	112.50	598.00
8.0SMDJ58A	8.0SMDJ58CA	8PGG	8BGG	64.40	71.20	1	58.00	5.00	85.50	93.60	120.90	555.80
8.0SMDJ60A	8.0SMDJ60CA	8PGK	8BGK	66.70	73.70	1	60.00	5.00	82.70	96.80	125.10	537.20
8.0SMDJ64A	8.0SMDJ64CA	8PGM	8BGM	71.10	78.60	1	64.00	5.00	77.70	103.00	133.10	504.90
8.0SMDJ70A	8.0SMDJ70CA	8PGP	8BGP	77.80	86.00	1	70.00	5.00	71.00	113.00	146.00	461.50
8.0SMDJ75A	8.0SMDJ75CA	8PGR	8BGR	83.30	92.10	1	75.00	5.00	66.20	121.00	156.30	430.30
8.0SMDJ78A	8.0SMDJ78CA	8PGT	8BGT	86.70	95.80	1	78.00	5.00	63.50	126.00	162.80	412.80
8.0SMDJ85A	8.0SMDJ85CA	8PGV	8BGV	94.40	104.00	1	85.00	5.00	58.40	137.00	177.00	379.60
8.0SMDJ90A	8.0SMDJ90CA	8PGX	8BGX	100.00	111.00	1	90.00	5.00	55.00	146.00	188.60	357.50

**Note:**

For bidirectional type having V<sub>R</sub> of 20 volts and less, the I<sub>R</sub> should be doubled.

# TVS Diodes

Transient Voltage Suppression Diodes

8.0SMDJ Series

## I-V Curve Characteristics

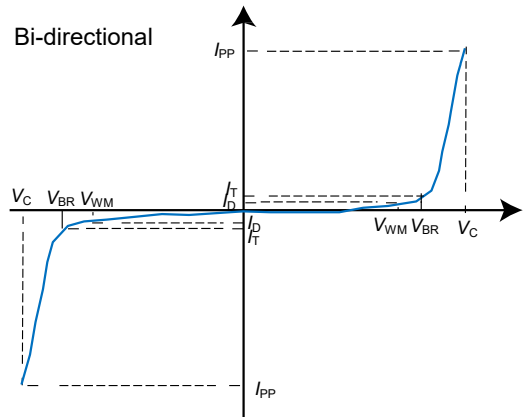
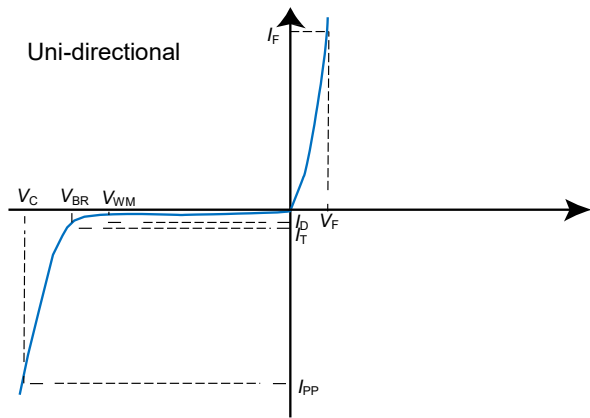

Performance Curve for Reference ( $T_A=25^\circ\text{C}$  unless otherwise noted)

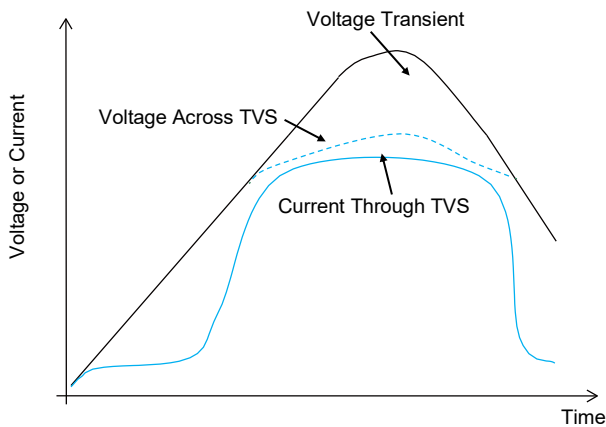

FIGURE 1 TVS Transients Clamping Waveform

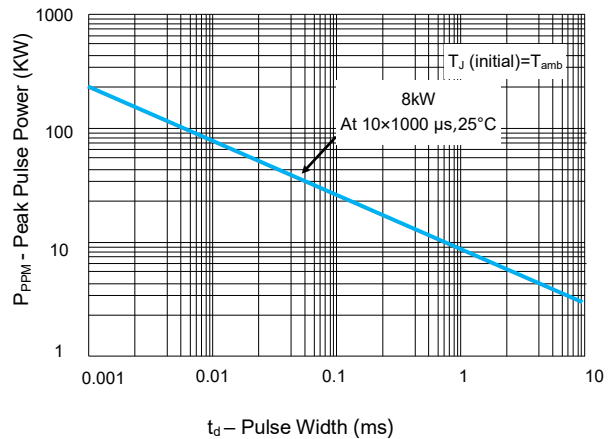

FIGURE 2 Peak Pulse Power Rating Curve

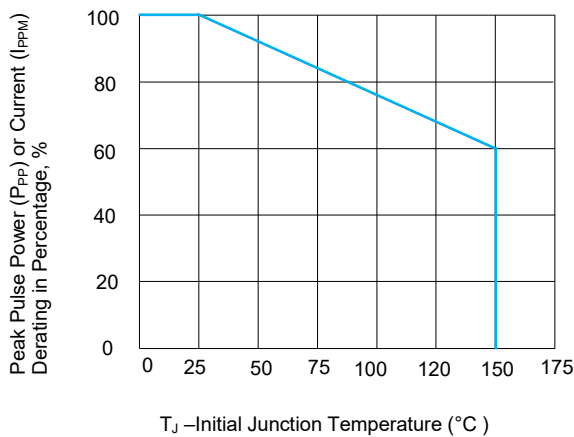

FIGURE 3 Peak Pulse Power Derating Curve

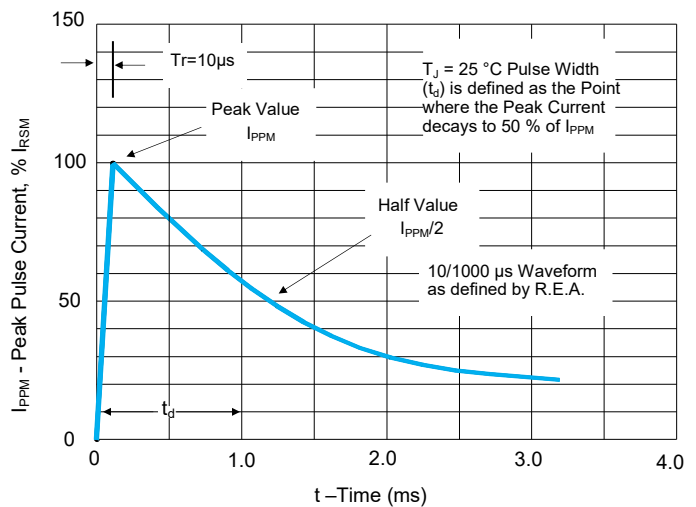

FIGURE 4 Pulse Waveform

# TVS Diodes

Transient Voltage Suppression Diodes

8.0SMDJ Series

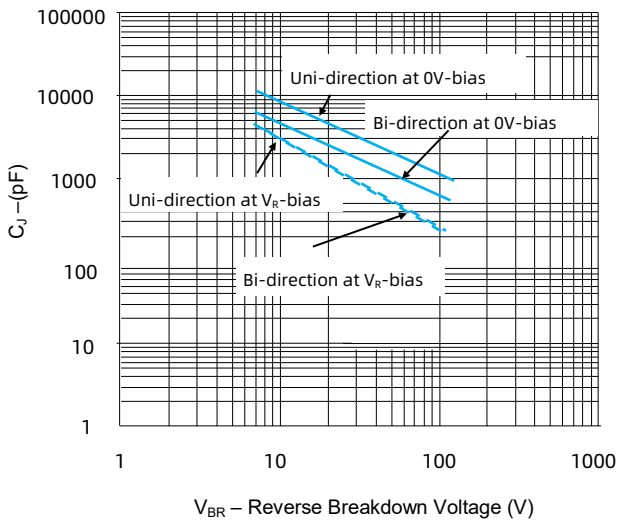

FIGURE 5 Typical Junction Capacitance

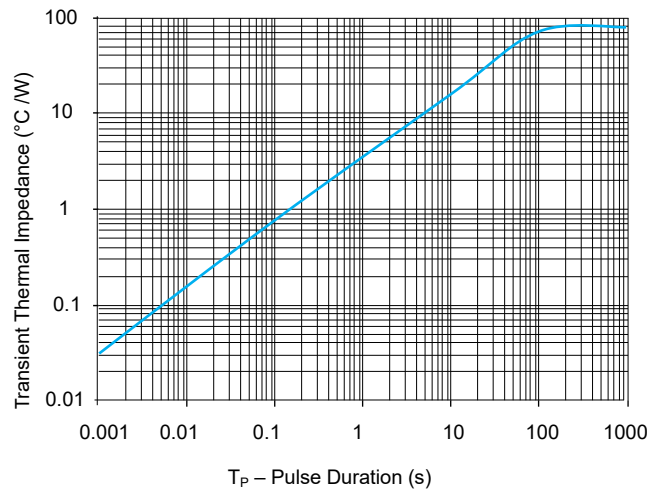

FIGURE 6 Typical Transient Thermal Impedance

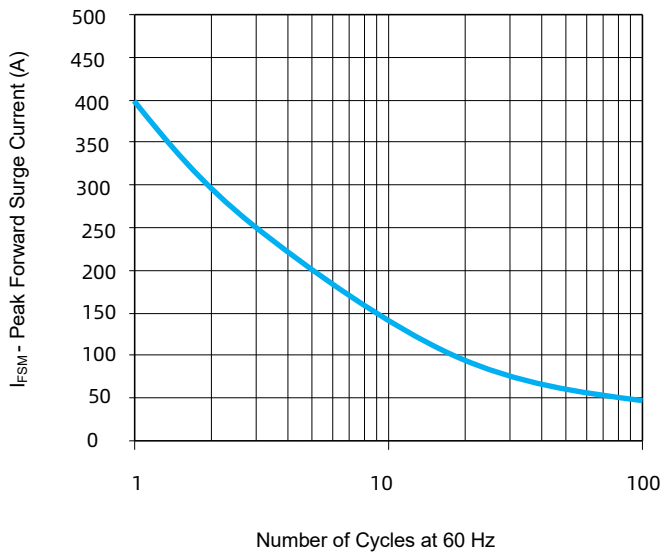

FIGURE 7 Maximum Non-Repetitive Forward Surge Current Uni-Directional only

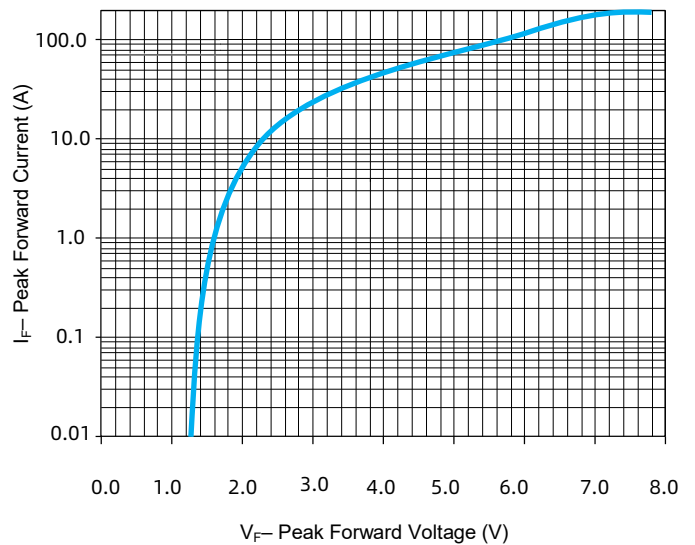

FIGURE 8 Peak Forward Drop vs Peak Forward Current (Typical Values)

## Environmental Specifications

High Temp. Storage	JESD22-A103
HTRB	JESD22-A108
Temperature Cycling	JESD22-A104
MSL	JESDEC-J-STD-020, Level 1
H3TRB	JESD22-A101
RSH	JESD22-A111

## Physical Specifications

Weight	0.007 ounce, 0.21 grams
Case	JESD22DO214AB. Molded plastic body over glass passivated junction
Polarity	Color band denotes positive end (cathode) except Bidirectional
Terminal	Matte Tin-plated leads, Solderability per JESD22-B102

Soldering Parameters

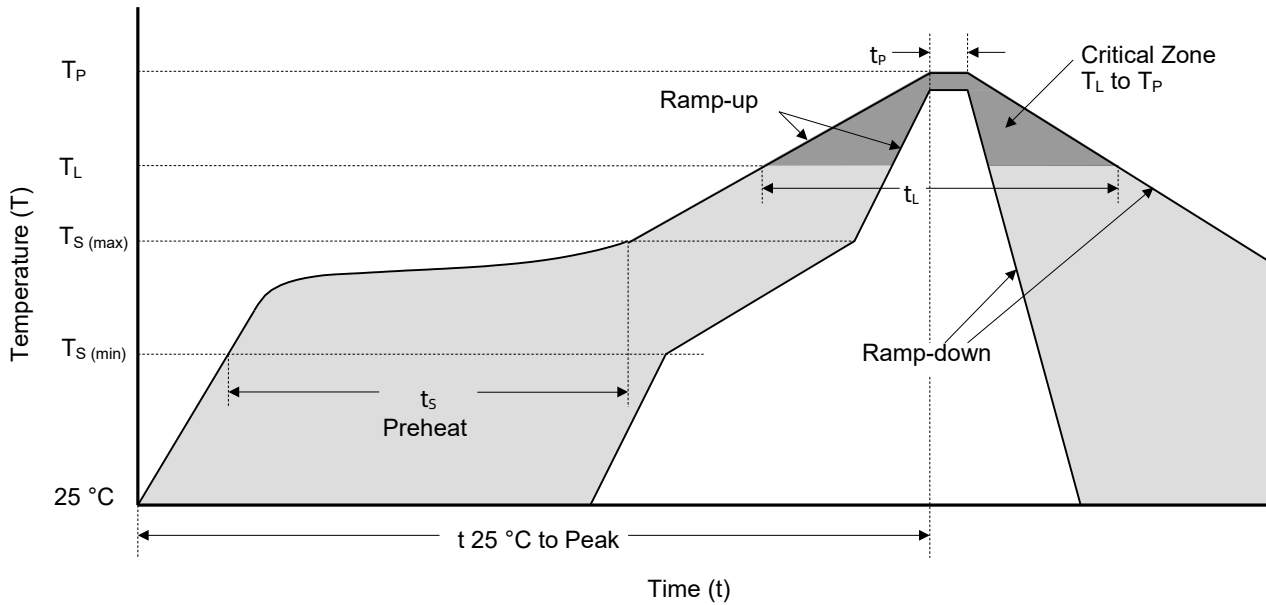

Reflowing Condition

Reflow Soldering Parameters		Lead-Free Assembly
Pre-heat	Temperature Min ( $T_{S (min)}$ )	150 °C
	Temperature Max ( $T_{S (max)}$ )	200 °C
	Time (min to max) ( $t_s$ )	60 ~ 120 seconds
Average Ramp Up Rate (Liquidus Temp ( $T_L$ ) to Peak)		3 °C / second max.
$T_{S (max)}$ to $T_L$ Ramp-up Rate		3 °C / second max.
Reflow	Temperature ( $T_L$ ) (Liquidus)	217 °C
	Time (min to max) ( $t_L$ )	60 ~ 150 seconds
Peak Temperature ( $T_P$ )		260 <sup>+0/-5</sup> °C
Time of within 5 °C of Actual Peak Temperature ( $t_p$ )		20 ~ 40 seconds
Ramp-down Rate		6 °C / second max.
Time from 25 °C to Peak Temperature		8 Minutes max.
Do Not Exceed		260 °C



# TVS Diodes

Transient Voltage Suppression Diodes

8.0SMDJ Series

## Packaging Information

Tape	Symbol	Dimension (mm)
	W	16.00 + 0.3 / -0.1
	P <sub>0</sub>	4.00 ± 0.10
	P <sub>1</sub>	8.00 ± 0.10
	P <sub>2</sub>	2.00 ± 0.10
	D <sub>0</sub>	1.55 ± 0.05
	D <sub>1</sub>	1.55 ± 0.05
	E	1.75 ± 0.10
	F	7.50 ± 0.10
	A <sub>0</sub>	6.15 ± 0.10
	B <sub>0</sub>	8.30 ± 0.10
	K <sub>0</sub>	2.48 ± 0.10
	T	0.30 ± 0.05

Reel Size	13" Reel	
	A	330 mm
	C	13.2 mm
	W <sub>1</sub>	16.4 mm

Part Number	Package	QTY (Reel)	Packaging Option	Packaging Specification
8.0SMDJxxxXX	DO-214AB	3000 PCS	Tape & Reel – 16 mm tape/13" reel	EIA STD RS-481
8.0SMDJxxxXX-T7	DO-214AB	500 PCS	Tape & Reel – 16 mm tape/7" reel	EIA STD RS-481



# ATTENTION

## Usage

1. TVS must be operated in the specified ambient temp.
2. Do not clean the TVS with strong polar solvent such as ketone, esters, benzene and halogenated hydrocarbon, to avoid damaging the encapsulating layer.
3. Please do not apply severe vibration, shock or pressure to TVS, to avoid element cracking.

## Replacement

1. If TVS is visually damaged, please replace it.
2. TVS is a non-repairable product. For safety sake, please use equivalent TVS for replacement.

## Storage

1. Storage Temp. Range: (-55 to 150) °C.
2. Do not store the TVS at the high temp., high humidity or corrosive gas environment, to avoid influencing the solder-ability of the lead wires. The product shall be used up within 1 year after receiving the goods.

## Environmental Conditions

1. TVS should not be exposed to the open air, nor direct sunshine.
2. TVS should avoid rain, water vapor or other condition of high temp. and high humidity.
3. TVS should avoid sand dust, salt mist, or other harmful gases.

## Max. Typical Capacitance of TVS

The typical capacitance of TVS is listed in the specifications. Designers may refer to it when designing TVS in High frequency circuit.

## Installation Mechanical Stress

1. Do not knock TVS when installing, to avoid mechanical damage.
2. Please do not apply severe vibration, shock or pressure to TVS, to avoid surface resin or element cracking.

### Transient Voltage Suppressor ( Surface Mount ) Features Overview

Package Type	Series									
	DO-221AC	DO-214AA	DO-214AB	DO-214AC	SOD-123FL	SMT0-218	SMA6L	SACB	SMBJ	P6SMB
Product Outline (mm)										
$V_R / V_{WM}$ (V) Reverse Stand-off Voltage	5.0 ~ 250	5.0 ~ 85	5.0 ~ 440	5.8 ~ 468		5.0 ~ 250		5.0 ~ 50	5.0 ~ 440	5.8 ~ 512
$P_{PPM}$ (W) (10/1000 $\mu$ s) Rated Peak ImPulse Power Dissipation	200		400			600		500	600	
$I_{PPM}$ (kA)(8/20 $\mu$ s) Rated Peak ImPulse Current										
Operating Temperature (°C)										-55 to +150

### Transient Voltage Suppressor ( Surface Mount ) Features Overview

Package Type	Series									
	DO-221AC	DO-214AA	DO-214AB	DO-214AC	SOD-123FL	SMT0-218	SPC1	SPC3	SPC6	SPC10
Product Outline (mm)										
$V_R / V_{WM}$ (V) Reverse Stand-off Voltage	5.0 ~ 440	5.8 ~ 512	5.0 ~ 440	12 ~ 170	12 ~ 110	380 / 430	66	58 ~ 76	58 ~ 86	
$P_{PPM}$ (W) (10/1000 $\mu$ s) Rated Peak Impulse Power Dissipation	1500		3000	5000	8000					
$I_{PPM}$ (kA)(8/20 $\mu$ s) Rated Peak Impulse Current						1	3	6	10	
Operating Temperature (°C)			-55 to +150					-55 to +125		

**Transient Voltage Suppressor ( Axial Lead ) Features Overview**

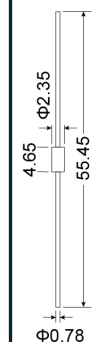
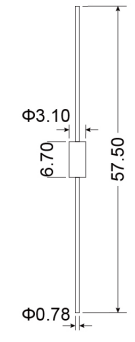
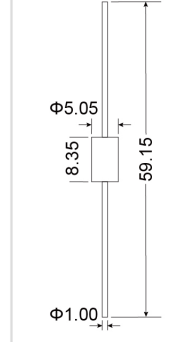
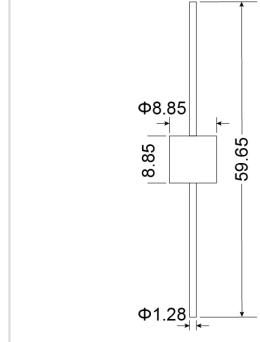
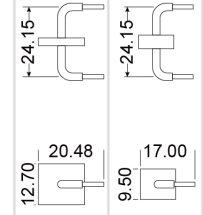
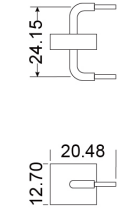
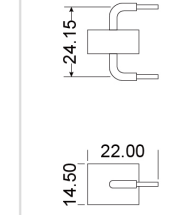
Package Type	Series															
DO-201	○	○	○	1.5KE	LCE	○	○	○	○	○	○	○	○	○	○	○
DO-41	P4KE	○	○	○	○	○	○	○	○	○	○	○	○	○	○	○
DO-15	○	SAC	P6KE	○	○	○	○	○	○	○	○	○	○	○	○	○
P600	○	○	○	○	○	5KP	15KPA	20KPA	30KPA	○	○	○	○	○	○	○
Radial lead	○	○	○	○	○	○	○	○	○	SPCL1	SPCL3	SPCL6	SPCL10	SPCL15	SPCL20	
Product Outline (mm)																
$V_R / V_{WM}$ (V) Reverse Stand-off Voltage	5.8 ~ 468	5.0 ~ 50	5.8 ~ 512	5.8 ~ 512	6.5 ~ 90	5.0 ~ 250	17 ~ 280	20 ~ 300	28 ~ 360	76	15 ~ 430	30 ~ 430	15 ~ 530	58 ~ 380	16 ~ 76	
$P_{PPM}$ (W) (10/1000 $\mu$ s) Rated Peak Impulse Power Dissipation	400	500	600	1500	5000	15000	20000	30000					○			
$I_{PPM}$ (kA)(8/20 $\mu$ s) Rated Peak Impulse Current										1	3	6	10	15	20	
Operating Temperature (°C)					-55 to +150								-55 to +125			